

AIRMAN

SG

INSTRUCTION MANUAL

ENGINE GENERATOR

SDG25S-8E1
SDG45S-8E1

[ENVIRONMENTAL CONTAINMENT
BASE TANK TYPE]

Please be sure to read this manual
before using this machine.

HOKUETSU INDUSTRIES CO., LTD.

1. Safety

This manual explains and illustrates general requirements for safety and cautions for safety.

Please read these safety requirements carefully and fully understand the contents before starting the machine.

For your better recognition, according to the degree of potential danger harmful to a human body, safety messages are classified into three hierarchical categories, namely, **▲ DANGER**, **▲ WARNING**, and **▲ CAUTION** with a caution symbol **▲** attached to each message.

When one of these messages is found, please take preventive measures for safety to carry out "SAFETY OPERATION AND PROPER MAINTENANCE OF THE MACHINE".

▲ DANGER

DANGER indicates an imminently hazardous situation which, if not avoided, will result in death or serious injury. This signal word is to be limited to the most extreme situations.

▲ WARNING

WARNING indicates a potentially hazardous situation which, if not avoided, could result in death or serious injury.

▲ CAUTION

CAUTION indicates a potentially hazardous situation which, if not avoided, may result in minor or moderate injury. It may also be used to alert against unsafe practices.

IMPORTANT

IMPORTANT indicates important caution messages for the performance or durability of the machine, which has no concern to injury or accident of or to a human body.

Follow warnings mentioned in this manual. This instruction manual does not describe all safety items. We, therefore, advise you to pay special attention to all items (even though they may not be described in the manual) for your safety.

Preface

Thank you for having selected our "AIRMAN" product.

- ◆ This manual explains about the proper operation and daily inspection and maintenance of this machine.
- ◆ In order to use a machine safely, people with sufficient knowledge and sufficient technology need to deal with it.
- ◆ Before operating the machine, read the manual carefully, fully understand its operation and maintenance requirement. Maintain "SAFETY OPERATION AND PROPER MAINTENANCE OF THE MACHINE".

Be sure to follow safety warnings and cautions given in the manual.
Unsafe operation could cause serious injury or death.

- ◆ For details of handling, maintenance and safety of the engine, see the Engine Operation Manual.
- ◆ Keep the manual available at all times for the operator or safety supervisor.
- ◆ When this manual is missing or damaged, order it from our office nearby or distributor.
- ◆ Be sure that the manual is included with the machine when it is handed over to another user.
- ◆ There may be some inconsistency in detail between the manual and the actual machine due to improvements of the machine. When you have anything unclear or you want to advise us, contact our office nearby or distributor.
- ◆ If you have any questions about the machine, please inform us the model and serial number. A plate stamped with the model and serial number is attached to side of the machine.

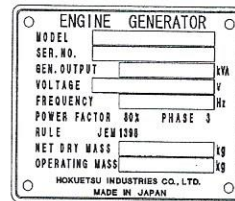

A040491

- ◆ Each illustrated figure (Fig.) has a number (for instance, A040491) at the right bottom. This number is not a part number, but it is used only for our reference number.

1. Safety

1.1 Caution before Operation

▲ WARNING

Follow the safety instructions

- Read each instruction plate which is displayed in the manual or on the machine carefully, understand its content and follow the indications thereof.
- Keep the Safety Warning labels clean. When they are damaged or missing, apply new ones.
- Do not modify the machine without prior approval. The safety may be compromised, functions may be deteriorated, or machine life may be shortened.
- Never use the machine for the other purposes than power supply. Otherwise, serious accidents may occur.

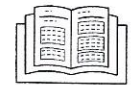

TR0086

▲ WARNING

Ventilation

- Exhaust gas from the engine is poisonous, and could cause casualties when it is inhaled. Avoid using the machine in an insufficiently ventilated building or a tunnel.



PC002

▲ WARNING

Handling battery

- Keep flames away from battery. Battery may generate hydrogen gas and may explode.
- Battery electrolyte is dilute sulfuric acid. In case of mishandling, it could cause skin burning.
- Wear protective gloves and safety glasses when handling a battery.
- Dispose of battery, observing local regulations.



DD04



TR0093

1.Safety

CAUTION

- When handling machine, do not wear,
 - loose clothes
 - clothes with unbuttoned sleeves
 - hanging tie or scarf
 - dangling jewelry
- Such outfit could be caught in the machine or dragged in the rotating portion of the machine, and could cause a serious injury.

Safety outfit



TR0084

CAUTION

Maintain both physical and mental health

- Do not operate the machine when you are tired or drunk or under the influence of drugs. Otherwise, a hasty conclusion or careless handling may cause unexpected injury or accident. Manage your physical and mental health and be cautious in handling the machine.

CAUTION

Protection equipments

- Please wear protection implements, such as a helmet, protection glasses, earplugs, safety shoes, a glove, and a protection-against-dust mask, according to the contents of work for safety.



TR0085

CAUTION

Safety fittings

- Have first-aid boxes and fire-extinguishers near the machine ready for emergency situations such as injuries and a fire.
- It is advisable to have a list of phone numbers of doctors, ambulance and the fire department available in case of emergency.



TR0086

CAUTION

Safety around the machine

- Such things as unnecessary equipment and tools, cables, hoods, canvas sheets and pieces of wood which are a hindrance to the job, have to be cleared and removed. This is because operators and personnel nearby may stumble on them and may be injured.

1-3

1.Safety

1.2 Caution during Operation

WARNING

Never touch the output terminals and interior of control board

- Never touch the output terminals during operation. Notice that the voltage of several hundreds volt is applied to the output terminal.
- When removing or connecting a connecting cable for changing load, be sure to switch OFF the circuit breaker, remove the starter key from the starter switch, then carry out a work. The operator must keep the key during operation. Neglecting the cautions mentioned above, and a third party starting the machine during operation may cause serious accidents such as electric shock.



H990208

WARNING

Hands off from rotating parts and belts

- Keep hands off from the rotating portion or belts while running. It could cause serious injuries if hands should be caught in.



TR0304

CAUTION

Do not remove radiator cap during operation

- Do not, under any circumstance, open the radiator cap while running or immediately after stopping operation. Otherwise high temperature steam jets out and this could cause scalding.



H990432

1-4

1.Safety

CAUTION

- Never work nearby hot portions of the machine while it is running.
- Do not touch hot portions of the machine while inspecting the machine when running.
- Such parts as engine, exhaust manifold, exhaust pipe, muffler, and radiator are especially hot, so never touch those parts, because it could cause scalding.
- Coolant water and engine oil are also very hot and dangerous to touch. Avoid checking or refilling them while the machine is running.

Do not touch hot parts



H990432

CAUTION

- Do not, under any circumstance, bring lit cigarettes or matches near such oils as diesel fuel oil, and engine oil, etc. They are extremely flammable and dangerous, so be careful when handling.
- Refilling oils should be done in an outdoor well-ventilated place.
- Refuel after stopping the engine, and never leave the fuel nearby the machine. Do not spill. It may cause a fire. When it is spilled, wipe it up completely.
- Do not fill fuel oil up to the cap level. When fuel tank is filled up to the cap level, fuel oil will be overfilled due to volume expansion caused by rise of ambient temperature. Further, fuel will be possibly spilled from fuel tank due to vibration caused during movement and/or transportation of machine.
- Such parts as muffler and exhaust pipe can be extremely hot. Remove twigs, dried leaves, dried grass and waste paper, etc. from the exhaust outlet of the muffler.
- Keep a fire extinguisher available by the machine in case of unexpected fire.

Fire prevention



D004



H990433

1-5

1.Safety

1.3 Caution during Inspection and Maintenance

WARNING

Hang a "Now Checking and under Maintenance" tag

- Before starting inspection, switch off the circuit breaker of this machine, remove the starter key from the starter switch, and then hang a "Now Checking and under Maintenance" tag where it can be easily seen. The checker must keep the key during checking and maintenance.
- Remove the negative (-) side cable from the battery. If the above procedure is neglected, and another person starts operating the machine during check or maintenance, it could cause serious injury.

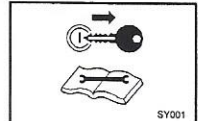

SY001

WARNING

Adjusting tension of belt

- Be sure to stop the engine and remove the starter key whenever the tension of the belt is to be adjusted.
- If the machine is running, it might catch the operator's hand into the belts, and this could cause a serious injury.



TR0304

WARNING

Hands off from cooling fan

- Be sure to stop the engine and remove the starter key whenever the tension of the belt is to be adjusted.
- If the machine is running, it might catch the operator's hand into the belts, and this could cause a serious injury.



W009

WARNING

Cleaning by air-blow

- When cleaning dust accumulated in such devices as the air-filter, etc., by blowing compressed air, wear safety glasses, etc. to protect your eyes.



W003

1-6

1.Safety

CAUTION

- It is recommended to use a lamp with safety guard fitted where the site is dark. Operating the machine gropingly or by relying on one's intuition could cause unexpected accidents. Any lamps without safety guard are not recommended since they can be broken and they could ignite flammables such as fuel, etc.

Lighting apparatus

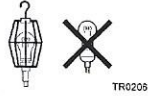

CAUTION

- Be sure to stop the engine, and let the coolant water sufficiently cool down before draining it.
- If the drain valve is opened before the coolant water is cooled enough, hot water could jet out, and it could cause scalding.

Opening coolant water drain valve



CAUTION

- After stopping the engine, wait 10 to 20 minutes until the engine oil cools off. Then check the level of the engine oil, or refill or drain the oil.
- The engine oil is very hot during operation and just after it stops. Be careful because the hot oil also pressurized blows off and it can cause burning.

Refilling or draining of engine oil



CAUTION

- When washing the machine, cover the control panel, generator and its electric parts to prevent them from being exposed to splashing water and avoid possible decrease in electrical insulation or other troubles to the machine.
- Dust, sand and dirt accumulated inside control panel could cause malfunction or trouble of the instruments. Clean them by blowing compressed air.

Caution of the cleaning

1-7

1.Safety

CAUTION

- The engine of this machine and electrical parts many electronic devices have been installed. If you do this please go airborne welding work, remove the connector of the electronic control equipment. Can cause equipment to malfunction due to electronic control of excessive current is applied.

Handling of electrical equipment engine

CAUTION

- Waste liquid from the machine contains harmful material. Do not discharge it onto the ground or into the river, lake or sea. Such material will pollute the environment.
- Be sure to use a container to hold the waste liquid from the machine.
- Be sure to follow the designated regulations when disposing of oil, fuel, coolant (antifreeze), filter, battery or other harmful materials.

Treatment of organic wastes

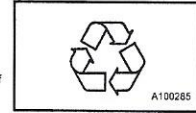

1-8

1.Safety

1.4 Safety Warning Labels

Following labels are attached to the machine.

Keep them clean at all times. If they are damaged or missing, immediately place an order with your nearest dealer for replacement. Part numbers are indicated on the lower right corner of the label. Adhere a new one to the original location.

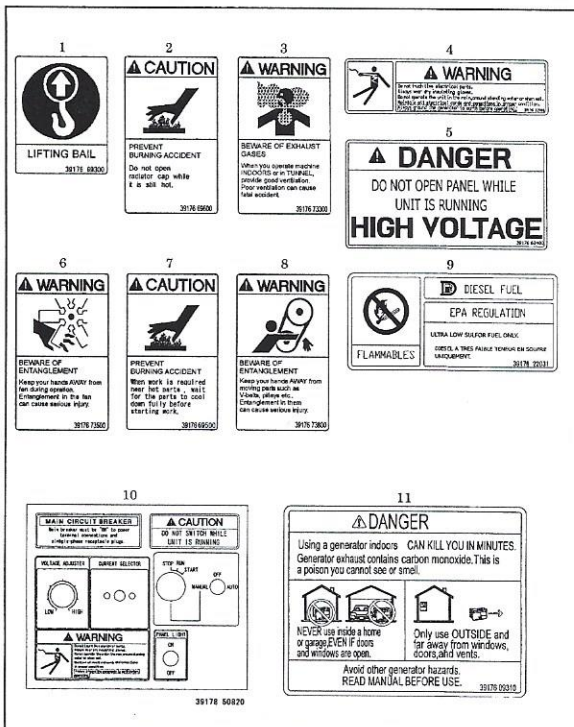

1-9

1.Safety

- The pasting position of safe warning label is as follows.

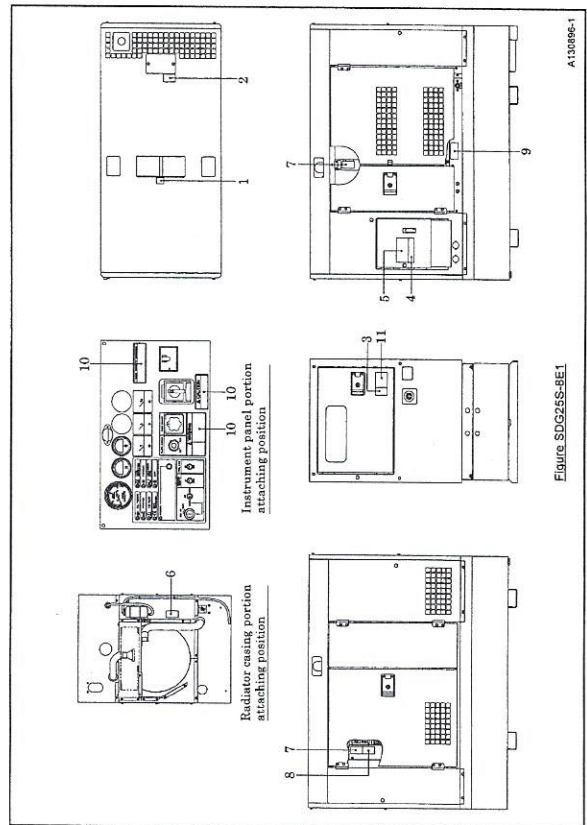

Figure 1-9

1-10

2. Part Names

2.1 Internal Components

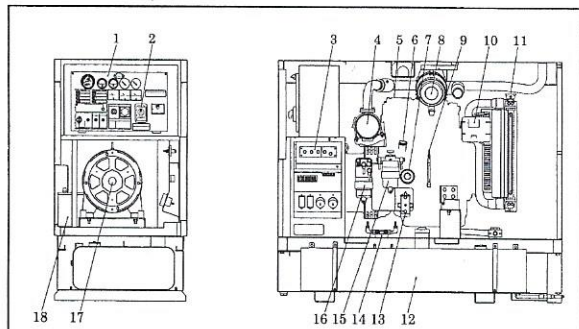

Figure SDG25S-8E1

A130901-1

No.	Description	Function
1	Control panel	For intensively controlling device of various meters and controls.
2	Voltage selector switch	For selecting output voltage.
3	Output terminals	Equipped with three phase and single-phase terminal and receptacle for single phase.
4	DOC (diesel oxidation catalyst)	Exhaust gas purifying device
5	Engine	For driving the generator main unit.
6	Engine oil filler port	For supplying or adding engine oil.
7	Engine oil filter	For filtering engine oil in the system.
8	Air filter	Filtering device for filtering dust floating in intake air.
9	Engine oil level gauge	For checking engine oil level.
10	Reserve tank	For checking coolant level and supplying it.
11	Radiator	For cooling the coolant for engine in the system.
12	Fuel tank	For storing fuel.
13	Fuel air-bleeding electromagnetic pump	For automatically bleeding air from fuel pipes.
14	Selector valve of fuel pipe	For supplying fuel oil from the tank provided outside.
15	Fuel filter	For filtering dusts or foreign things in fuel in the system.
16	Fuel pre filter	For filtering dust and foreign things mixed in fuel oil and also for separating water.
17	Generator main unit	For generating AC power to be supplied.
18	Battery	For electrically starting engines.

2-1

2. Part Names

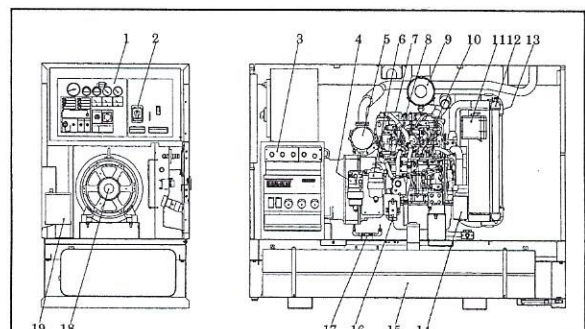

Figure SDG45S-8E1

A131066

No.	Description	Function
1	Control panel	For intensively controlling device of various meters and controls.
2	Voltage selector switch	For selecting output voltage.
3	Output terminals	Equipped with three phase and single-phase terminal and receptacle for single phase.
4	Fuel pre filter	For filtering dust and foreign things mixed in fuel oil and also for separating water.
5	DOC (diesel oxidation catalyst)	Exhaust gas purifying device
6	Fuel filter	For filtering dusts or foreign things in fuel in the system.
7	Engine	For driving the generator main unit.
8	Engine oil filler port	For supplying or adding engine oil.
9	Air filter	Filtering device for filtering dust floating in intake air.
10	Engine oil level gauge	For checking engine oil level.
11	Reserve tank	For checking coolant level and supplying it.
12	Radiator	For cooling the coolant for engine in the system.
13	Intercooler	For cooling air heated by engine.
14	Engine oil filter	For filtering engine oil in the system.
15	Fuel tank	For storing fuel.
16	Fuel air-bleeding electromagnetic pump	For automatically bleeding air from fuel pipes.
17	Selector valve of fuel pipe	For supplying fuel oil from the tank provided outside.
18	Generator main unit	For generating AC power to be supplied.
19	Battery	For electrically starting engine.

2-2

3. Installation

3.2 Conditions of Unit Installation

WARNING

- Exhaust gas from the engine is poisonous, and it could cause casualties when it is inhaled. Avoid using the machine in an insufficiently ventilated building or a tunnel. When the machine is unavoidably used in such insufficiently ventilated place, ventilation devices and ventilation pipe should be provided for better ventilation.

Ventilation

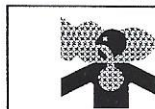

PC002

WARNING

- In case that the unit is installed indoors for operation, suction air port and exhaust fume outlet port should be provided for better air ventilation.
- Make sure to secure enough space in front of air suction port and also to secure it after exhaust fume outlet port so that the engine may not get overheated.
- Exhaust pipe or the like should be provided at the exhaust outlet port so as to send out exhaust fume outdoors.
- Also the cooling air outlet port of radiator should be provided outdoors through a duct or the like for air ventilation.

In case that the unit is installed indoors

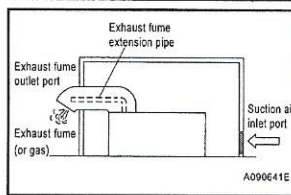

A090641E

WARNING

Installing the unit at such poorly-ventilated place

- In case that the unit is installed inside any tunnel, make sure to provide fresh air and ventilate it.
- In this case, make sure to extend the exhaust fume pipe outdoors, and also make sure to prevent any leak from any connection pipes. In case that the unit is operated under exhaust air pressure, make sure to install the exhaust pipe to be supported.

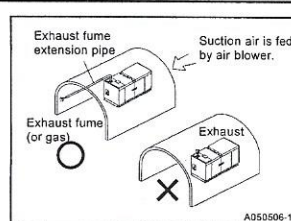

A050506-1

3-2

3. Installation

WARNING

- Never locate the unit with the exhaust muffler facing any private house.
- As the exhaust fume (gas) from the engine is poisonous, never direct it to any other persons passing by.

How to locate the unit

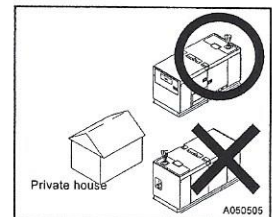

Private house

A050505

WARNING

- The machine has to be installed on dry, firm, and level area.
- Avoid installing the machine in a place such as a damp place or a place where puddles are apt to be formed after rain. Such installation could cause electric shock.
- When installing the machine at the sea shore or on a ship, make sure that the machine should not be exposed directly to sea water.
- When installing the machine at a sandy place, make sure that exhaust from the generator or radiator does not blow the sand up in the air, or into the machine.
- In case that the unit has to be installed inevitably on any rough and uneven ground; it is necessary to insert square wooden bars under the unit for levelling it.

Installation

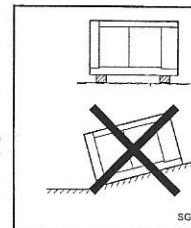

SG0103-1

- The machine should be operated in following conditions:
 - Ambient temperature: -5°F to 104°F (-15°C ~ $+40^{\circ}\text{C}$)
 - Humidity: Less than 85%
 - Altitude: Lower than 1,000m above sea level
- If more than two machines are placed parallel in operation, keep enough distance so that exhaust air from one machine does not effect the other one.
- Keep enough space around the unit for inspection and maintenance access.

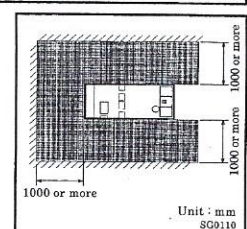

Unit : mm
SG0110

3-3

3. Installation

CAUTION

- In order to prevent from entering the jobsite or touching the equipment any other persons than the persons engaged in the job, please prepare for safety fences around the unit:

Preparation of safety fences

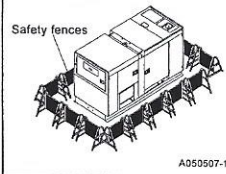

3-4

3. Installation

3.3 Grounding method

3.3.1 Ground terminal

AC output terminal plate "1" is connected to the grounding position of the unit and to the grounding terminal of each electrical outlet.

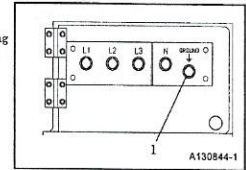

3.3.2 Connections to a building's electrical system

Connections for standby power to a building's electrical system must be made by a qualified electrician. The connection must isolate the generator power from utility power, and must comply with all applicable laws and electrical codes.

WARNING

- Improper connections to a building's electrical system can allow electrical current from the generator to backfeed into the utility lines. Such backfeed may electrocute utility company workers or others who contact the lines during a power outage. Consult the utility company or a qualified electrician.
- Improper connections to a building's electrical system can allow electrical current from the utility company to backfeed into the generator. When utility power is restored, the generator may explode, burn, or cause a fire in the building's electrical system.

3.3.3 Ground system

AIRMAN's generators have a system ground that connects generator frame components to the ground terminals in the AC output receptacles. The AC neutral wire is connected to the system ground.

3-5

3. Installation

3.3.4 GFCI (Ground-fault circuit interrupter) Receptacles

WARNING

- Using the generator in rain, snow or near water can lead to death from electric shock. Keep the generator dry.

All of the 20 ampere 120 volt receptacles on the generator are protected by a GFCI (Ground-fault circuit interrupter) for protection against the hazards of ground fault currents. An example of ground-fault current is the current which would flow through a person who is using an appliance with faulty insulation and, at the same time, is in contact with an electrical ground such as a plumbing fixture, wet floor, or earth.

The ground-fault circuit interrupter will not protect against short circuits or overloads. The circuit breaker in the control panel which supplies power to the circuit provides that protection.

The ground-fault circuit interrupter can be identified by the TEST and RESET buttons. The receptacles on the GFCI can be tested with the TEST and RESET buttons.

TEST BUTTON: To test, depress the "TEST" button. (power is turned off)
RESET BUTTON: To restore power, depress the "RESET" button.

Perform this test monthly or every 250 hours operation whichever comes first, in order to ensure proper operation of the GFCI receptacle. If the generator is stored outdoors, unprotected from the weather, test the GFCI receptacle before each use. Record your test on the GFCI test card provided on the control panel.

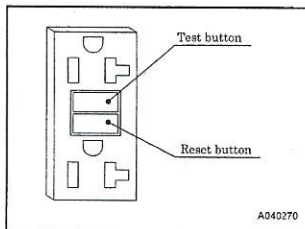

3-6

3. Installation

Grounding method

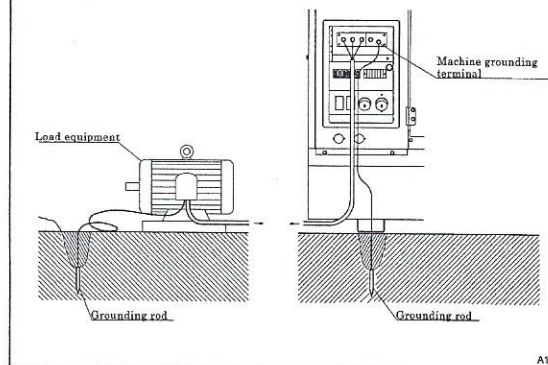

3-7

3. Installation

3.4 Selecting cable

- Select a cable with sufficient diameter by considering the permissible current on the cable and the distance from the generator to the load.
- If the current flowing to the load exceeds the permissible current of the cable, resultant overheating may burn the cable. Similarly, if the cable is too small in thickness to the length, the input voltage to the load will fall to cause the load input power to drop, as a result, the performance of the machine cannot be displayed.

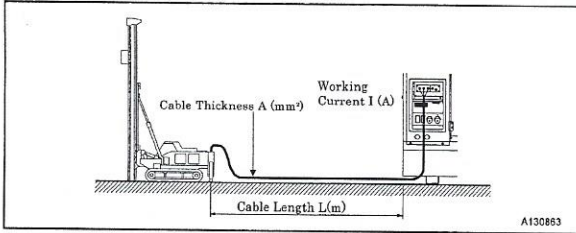

A130853

- Simplified three-phase three-wire formula to seek voltage drop or cross-sectional area of the cable from cable length and working current. Select such a cable length and thickness so that the voltage drop will remain less than 5%.

Output system	Voltage drop	Cross-sectional area of the cable	e : Voltage drop(V) e' : Voltage drop between an outside line or one line of each phase, and a neutral line (V) A : Cable thickness (mm²) L : Cable length (m) I : Working current (A)
Three-phase 3-wire Type	$e = \frac{30.8 \times L \times I}{1,000 \times A}$	$A = \frac{30.8 \times L \times I}{1,000 \times e}$	
Three-phase 4-wire Type	$e = \frac{17.8 \times L \times I}{1,000 \times A}$	$A = \frac{30.8 \times L \times I}{1,000 \times e}$	

- The following tables show the relations between the cable length and the cable thickness (nominal cross-sectional area) suited to the working current. (Based on the condition that working voltage is 200 V, with voltage drop of 10V.)

Single-Conductor Cable

Unit:mm²

Current	Length					
	50m	75m	100m	125m	150m	200m
50A	8	14	22	22	30	38
100A	22	30	38	50	50	60
150A	38	38	50	60	80	100

Three-Conductor Cable

Unit:mm²

Current	Length					
	50m	75m	100m	125m	150m	200m
50A	14	14	22	22	30	38
100A	38	38	38	50	50	60
150A	22×2	22×2	38×2	38×2	38×2	50×2

3-8

3. Installation

3.5 Selector valve of fuel pipe

CAUTION

- Always keep watching the fuel feeding conditions while feeding fuel from a separate fuel storage tank separately installed.
- In order to use a separator fuel storage tank, be sure to change the handles of the selector valves to a predetermined position. If you make a mistake in turning the handles, it can burst the fuel pipe and cause overflowing. It could lead to a serious accident.
- If excessive force is loaded to the selection handle, it will not move smoothly and it could cause fuel leakage. Be careful about the handle.

3.5.1 Selector valve

This valve is designed to feed fuel directly to the engine of the unit, not from the tank integrated in the unit, but from a fuel tank installed separately.

3.5.2 Operation method

- Unit is delivered from factory with fuel line piping and selector valves built in as shown in the following Fig.1. When operating a unit, using installed fuel tank, run the machine with the fuel line piping and the handles of selector valves arranged.
- When using a separate storage tank, remove the plug fitted at the connections to the separator tank and make piping as shown in Fig.2. And then turn the handles of the selector valve as shown in Fig.2.
- When removing the piping connections, make sure to return the handles to the original positions shown in Fig.1 and install the plugs.

3.5.3 Installation of separate storage fuel tank and piping method

- Use oil resistant hoses of inside diameter of 8mm to 10mm.
- Install the fuel tank so that the fuel level of the tank may be kept at the level from zero to 2.5m high from the machine installation level.
- In order to avoid suction of water and sediment together, install the suction pipe so that the inlet port of suction pipe may be kept at the 15mm to 20mm higher level than the bottom line of the tank. Also install the outlet port of the return pipe inside the tank. (see Fig.2 · A)
- When refilling fuel in the tank, take much care not mix water and sediment.

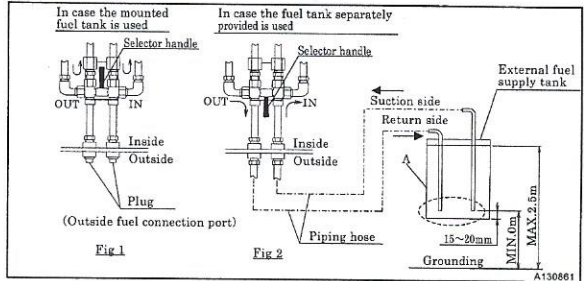

3-9

4. Operation

4.1 Instrument panel

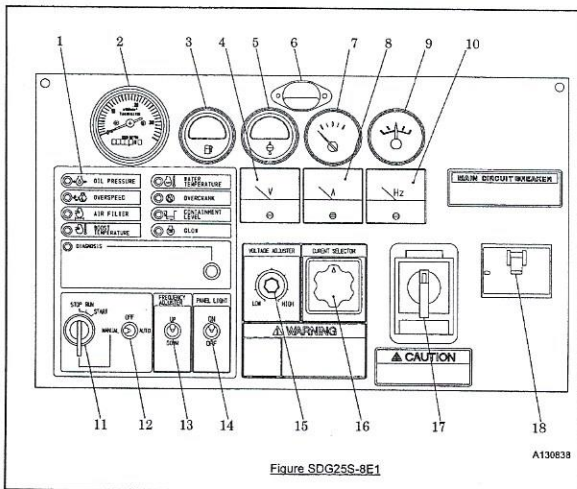

A130838

- Monitor lamp (for details, see 4.2.1)
- Tachometer with hourmeter
- Fuel gauge
- Voltmeter
- Coolant temperature gauge
- Panel light
- Engine oil pressure gauge
- Ammeter
- Ammeter for battery charge
- Frequency meter
- Starter switch
- Manual-automatic change-over switch
- Frequency adjuster switch
- Panel light switch
- Voltage adjuster switch
- Ammeter change-over switch
- Voltage selector switch
- Main circuit breaker

4-1

4. Operation

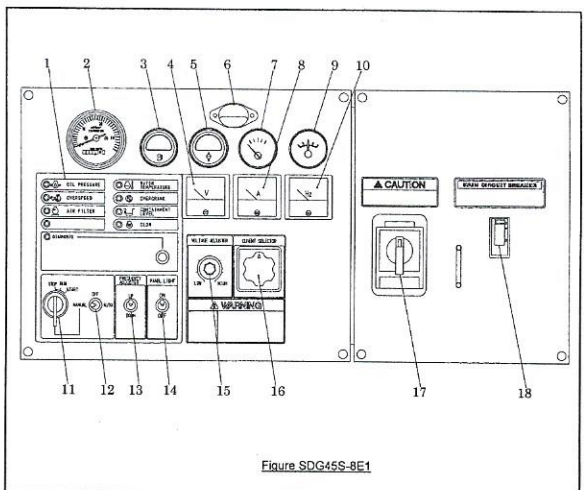

Figure SDG45S-8E1

- Monitor lamp (for details, see 4.2.1)
- Tachometer with hourmeter
- Fuel gauge
- Voltmeter
- Coolant temperature gauge
- Panel light
- Engine oil pressure gauge
- Ammeter
- Ammeter for battery charge
- Frequency meter
- Starter switch
- Manual-automatic change-over switch
- Frequency adjuster switch
- Panel light switch
- Voltage adjuster switch
- Ammeter change-over switch
- Voltage selector switch
- Main circuit breaker

4-2

4. Operation

4.2 Protection device

⚠ WARNING

- For prevention of troubles during operation, this machine is provided with various protection devices. When the engine stops due to function of the protection devices and circuit breaker trips, get rid of the causes of trouble, referring to the trouble shooting clause and then restart operation.

4.2.1 List of protection devices

- This machine is equipped with the following devices in the table. Repair and make necessary treatment in accordance with the item ○.

Item	Engine stops	Three-phase circuit breaker trips	Lamp display	Monitor	Functions
Engine oil pressure drop	○	—	○	⚠	When engine oil pressure drops, it functions. Operating pressure: lower than 15psi (0.1MPa)
Excessive rotation	○	—	○	⚠	When engine rotates excessively, it begins to function. Function rotation: Under operation at 60Hz : 2,070min ⁻¹ (60Hz)
Clogging of air filter	—	—	○	⚠	When air filter is clogged and it becomes necessary to clean it, it functions.
Boost temperature rises	—	—	○	⚠	When boost temperature rises higher than 85°C, monitor lamp goes on.
Water temperature rises.	○	—	○	⚠	In case of abnormal rise of engine water temperature, it functions. temperature reaches 100°C
Over crank	○	—	○	⚠	This lamp goes on when operator fails to start engine, during automatic operation mode.
* Oil Fence	—	—	○	⚠	When more condensate (fuel, engine oil and coolant) than 1/3 of capacity in the oil fence is accumulated monitor lamp lights.
GLOW	—	—	○	⚠	When starter switch is "ON", the Monitor lamp glows and goes off after preheating is performed.
Overcurrent or short circuit	—	○	—	—	In case of overload or short circuit accident, it functions.
Engine troubles	—	—	○	—	Refer to 5.1.1 "Engine troubles"

* When the monitor lamp lights in the oil fence, immediately drain it. (For the capacity of the oil fence, refer to 8.1 Specifications). To protect environment, do not drain it directly into rivers. (For details, see 4.4)

4-3

4. Operation

4.2.2 Circuit-breaker

- In case overload and short-circuited wire connection should occur, the circuit-breaker trips.
- When this is tripped, stop the unit immediately and reset the circuit breaker after getting rid of the causes of trouble.

<How to reset>

- In order to reset the lever of circuit-breaker, press hard the lever downward till the lever sounds "click".

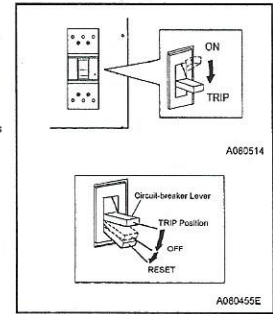

4.2.3 Thermal relay

- In case overload or short-circuit should occur to load or load connection cable, this relay functions to trip the circuit-breaker.
- It is not necessary to push the reset button even after the three phase main breaker is tripped since the thermal relay is set automatic return at factory.

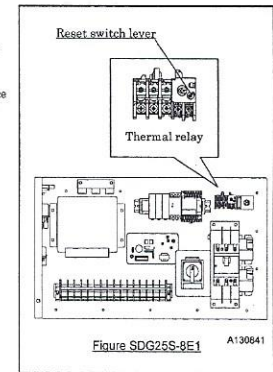

4-4

4. Operation

4.2.4 Circuit protector (CP) for AVR protection

AVR is equipped with circuit-protector (CP) for protection against overcurrent. Under the following cases, it happens to function.

- In case the machine gets overloaded while engine speed is still lower.
- In case the output voltage of generator is increased higher than the specified voltage.

<Symptom>

- When CP functions, voltage drops.

<How to reset>

- Reset it by pressing CP (AVR) button which is provided at the side of the breaker plate in the control panel.

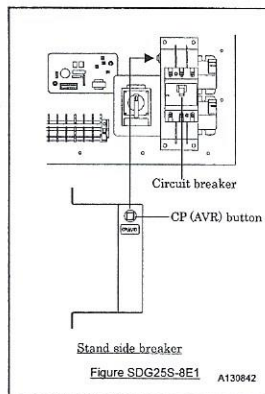

4-5

4. Operation

4.3 Connecting Load

⚠ WARNING

Electric shock and electric leak

- Make sure not to connect the output terminal of the machine with the commercial power source from electric power company. It may cause an electric shock, machine troubles and even a fire.
- Make sure to ground the machine and the load. It could cause an electric shock when the machine is installed at a damp place or on a steel frame or a steel plate.
- Never touch the output terminals during operation.
- Notice that the voltage of several hundreds volt is applied to the output terminal.
- When removing or connecting a connecting cable for changing load, be sure to switch OFF the circuit breaker, remove the starter key from the starter switch, then carry out a work. The operator must keep the key during operation.
- For a connecting cable to load, do not use a cable with damaged sheath nor an inappropriate insulation cable to the voltage. Secure connections between each cable terminal and input/output terminal. Otherwise, it may be slackened during operation and may cause a fire or an electric shock accident.

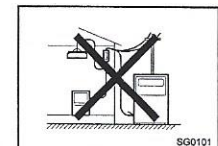

⚠ CAUTION

- When using a single-phase load [277V or 139V], see to it that the loads on the different phases will be evenly balanced. Unbalanced loads may cause the generator burning.

	SDG25S-8E1	SDG45S-8E1
Three-phase output (L1, L2, L3, N)	M8	M14
Leakage relay ground terminal(G)	M8	M14

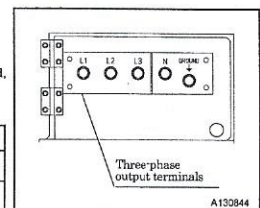

4-6

4. Operation

- Install a switch between the output terminal and the load to switch on/off the load. Do not switch the load on/off directly by the circuit-breaker of the generator. It could cause damage to the circuit-breaker.
- Connect the connecting cable to the load so that the output terminals should not touch each other.

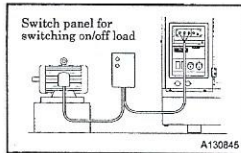

4.3.1 Proper Connection of Three-phase Four-wire Type Terminal

CAUTION

Never use voltage selector switch during operation

- During operation, do not operate voltage selector switch. Voltage selection during operation may cause abnormal voltage on the load side to damage the load and may cause a fire.
- In addition it could cause damage to generator and automatic voltage regulator (AVR).
- Be sure to shut off generator before using voltage selector switch.
- When voltage selection is completed, lock the voltage selector switch in position to prevent anyone from operating it.

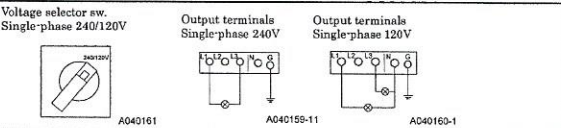
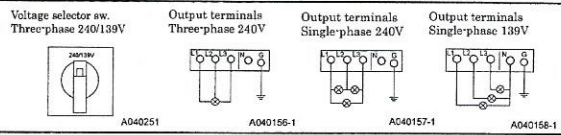
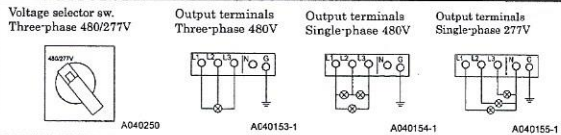
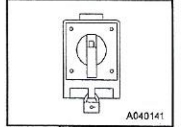

NOTE: When the voltage selector switch is in the single-phase 240/120V position, place the ammeter change-over switch to the L1 or L3 position to read the output.

4-7

4. Operation

4.3.2 Auxiliary AC Power

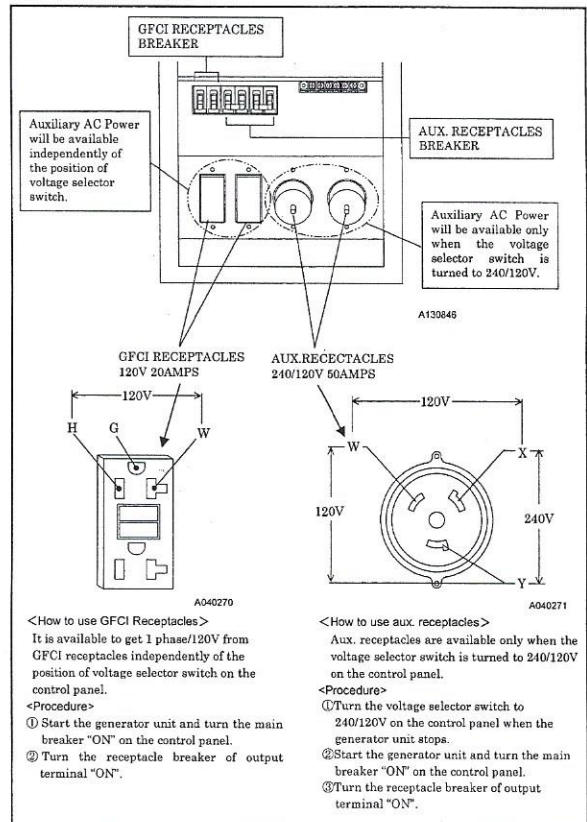

4-8

4. Operation

4.3.3 The Maximum Combined Simultaneous Power Consumption

CAUTION

- Never exceed the maximum combined simultaneous power consumption.

The following chart shows the maximum power available from the 120V-20A GFCI receptacles during simultaneous consumption (main terminals and receptacles) for both single or three phase settings. Values shown in the left column give the maximum current available at the 120V-20A GFCI receptacles compared to the value of the simultaneous current consumption from the main terminals.

Single Phase 120V-20A GFCI Recept.	SDG25S-8E1		SDG45S-8E1	
	Three Phase 240/480V	Single Phase 240/120V	Three Phase 240/480V	Single Phase 240/120V
kW	kVA	kVA	kVA	kVA
0.0	25.0	14.4	45.0	26.0
1.2	20.8	13.2	40.9	24.8
2.4	16.7	12.0	36.7	23.6
3.6	12.5	10.8	32.6	22.4
4.8	8.4	9.6	28.4	21.2

4.4 Engine Oil · Coolant · Fuel

4.4.1 Engine Oil

IMPORTANT

- Viscosity of engine oil greatly affects startability, performance, oil consumption of the engine, as well as wear of the moving parts. Choose appropriate oil based upon the table below according to the outside air temperature.

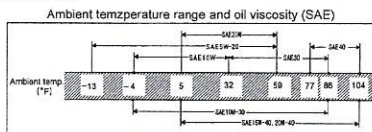

- Use engine oil recommended by us.

Classification	API service classification CJ-4
Viscosity	SAE10W-30

- Be sure to use CJ-4 class engine oil or superior class. (Using engine oil with poor quality may shorten the life of the engine).
- When two or more different brands of oil are mixed, its performance can be deteriorated. Do not mix oils.
- When it is expected to be used for a long period at light load (less than 20% load), it is better to replace the oil with suitable oil.
- Follow the designated regulations to dispose of engine oil.
- Unit is delivered ex. factory, filled with engine oil recommended by engine manufacturer.

4-9

4. Operation

4.4.2 Coolant

IMPORTANT

Quality of coolant and antifreeze

- Use soft water of good quality such as tap water for coolant.
- When water with dirt, sand, and/or dust contained, or hard water such as well water (ground water) is used, this will cause deposits inside radiator or on cylinder head, and will cause engine overheating due to poor flow of coolant.
- When the unit is used in a cold region and possible freezing is expected, it is recommended to use LLC (Antifreeze) for the coolant.
- Adjust mixing ratio of LLC with water according to the temperature.
- Use LLC within the range of its mixing ratio between 35 and 60%.
- If LLC in the water exceeds more than 60%, it may decrease its antifreezing effect. (Upon delivery from the works, LLC density is 55%)
- Follow the designated regulations to dispose of LLC (Antifreeze).

4.4.3 Fuel

IMPORTANT

Choose appropriate fuel

- Do not use such diesel fuel having higher sulfur content above 0.0010%(10 ppm)
- Use ultra-low sulfur diesel fuel only for diesel engine.
- Follow the designated regulations to dispose of fuel.

CAUTION

- Fuel for diesel engine must have the following specific characteristics.
 - It must be free from even minute dust particles in it.
 - It must have optimum viscosity.
 - It must have high cetane number.
 - It must have high fluidity even at low temperature.
 - Carbon residue content in fuel must be a little.

4-10

4. Operation

4.5 Check before Starting the Machine

WARNING

Check before starting the unit

- Be sure to check the machine before operation. When any abnormality is found, be sure to repair it before starting the unit.
- Be sure to make daily check before operation. If the unit is operated without prior check and without noticing its abnormality, such operation could cause seizure of components or may even cause fire.

4.5.1 Check engine oil level

- The machine should be on level before checking oil level.
- When you check oil level after you have once started operation, wait 10 to 20 minutes after stopping engine, before checking the oil level.

<Procedures>

- ① Pull out the engine oil level dipstick, and wipe it with a clean cloth.
- ② Then, reinsert the dipstick fully and pull it out again. If the gauge shows the oil level between ADD and FULL limits, it is normal.
- ③ When the oil level is below its ADD, add engine oil. (See 6.5.1.)
- While checking oil level, check also for contamination. If the oil is found dirty, contaminated, or should be changed according to the periodic inspection list, change the oil.

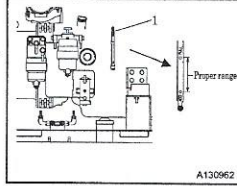

4.5.2 Check coolant level

CAUTION

Taking off the radiator cap

- Be sure to stop the machine first and then loosen the radiator cap slowly, after the coolant water is sufficiently cooled and the inner pressure is released. If this procedure is neglected, its inner pressure can blow off the cap, and steam jetting out of the radiator could cause scalding.



- Check the coolant level in the reserve tank. If it is lower than the limit, open the cap and replenish the coolant. (Level must be kept above LOW mark)
- If little coolant is left in the reserve tank, replenish the tank and radiator also. (See 6.5.19)

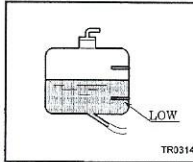

4-11

4. Operation

4.5.3 Check fuel

- Before starting operation, make sure to check the level of residual fuel so that fuel shortage during operation can be avoided.
- Drain condensate accumulated at the bottom of fuel tank whenever necessary.

CAUTION

Fire prevention

- Do not, under any circumstance, bring lit cigarettes and/or matches to the fuel.
- The fuel is extremely flammable and dangerous. Be careful of fire because it is very likely to catch fire.
- Refuel only after stopping the engine, and never leave open fuel can near the machine. Do not spill. It could cause a fire. When it is spilled, wipe it up completely.
- Refilling fuel tank should be done in an outdoor well-ventilated place.
- **Do not fill fuel oil up to the cap level. When fuel tank is filled up to the cap level, fuel oil will be overfilled due to volume expansion caused by rise of ambient temperature. Further, fuel will be possibly spilled from fuel tank due to vibration caused during movement and/or transportation of machine.**



4.5.4 Check fuel pre-filter and fuel filter for condensate

CAUTION

- At time of inspection, never use alcohol-base cleaner. If it sticks to such parts made of plastic, it causes degradation of liquid surface visibility, and in worst case, it leads to crack and fuel leak due to crack caused.

When the red float "2" below the interior element "2" of the fuel filter rises up to water drain level, it is necessary to drain water.

<Procedures>

- ① Both inlet and outlet ends of the fuel hose should be stopped with something as such clips.
- ② Drain condensed water accumulated inside, after loosening drain valve "3".
- ③ After draining the condensate, be sure to fasten the drain valve "3".
- Drain the condensate in container, and then dispose of condensate according to the designated regulations.

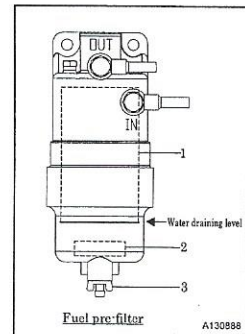

4-12

4. Operation

4.5.5 Check belt tension

IMPORTANT

- If belt tension too tight, it can cause shaft breakage or shorten the life of a bearing. If too loose, the belt may slip and will cause early breakage or damage to the belt.

- Adjust the belt by the following procedure:

<Procedures>

- ① Unfasten the mounting bolts of the alternator to adjust the alternator.
- ② Visually check the belt for any crack, wear, and other defect.
- ③ Loosen the mounting bolt of alternator once. Then adjust it so that the belt deflection will be 0.24 to 0.26in.(22lbs.) when pressing with a finger.
- ④ Be careful not to leave any grease and LLG on the belt. If any of such material is left, wipe it off completely.

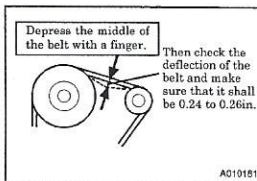

4.5.6 Check condensate in the oil fence

- A drain outlet is provided at the side of the oil fence. Remove the drain plug "1" and drain the condensate accumulated inside the oil fence.
- After making sure that the condensate is drained, install the drain plug "1".
- Drain the condensate in container, and then dispose of condensate according to the designated regulations.

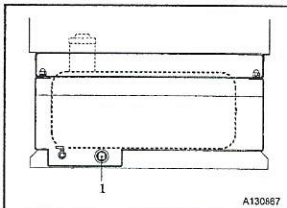

4.5.7 Cleaning the instruments inside control panel

- Before starting operation, open control panel and check each breaker, terminal plate and each controller for any dust, sand and dirt accumulated.
- If the machine is operated with such dust, sand and dirt sticking, it could cause malfunction and trouble of instrumentation. If any, stop the machine, and clean them by blowing compressed air. When doing cleaning job, wear protection glasses.

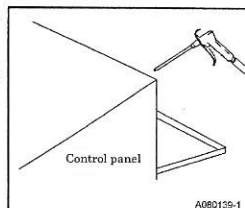

4-13

4. Operation

4.6 Unit Operation

WARNING

- Keep the door shut and locked when machine is in operation.
- If opening the door is necessary, be careful not to touch rotating or hot parts. Burns or serious injury could result.

IMPORTANT

- After the engine starts up, warm it up under unload for approx. five minutes.
- Warming up after starting up is necessary for smooth operation of the engine. Do not operate the engine at full load immediately after it starts up. This will shorten the equipment life.
- During the warm-up operation, examine the different parts of the equipment for any looseness, leakage of water, oil, fuel, and other irregularities, also, make sure that the alarm lamps are off.
- Be sure to operate the generator at a rated frequency, irrespective of the load capacity. If the machine is operated with a frequency lower than the rated frequency, it could cause the generator or to be burned.
- If the machine runs continuously without loads or with light loads for long period, the oil might be cozing from a turbo wastegate valve and an exhaust manifold. Oil cozing can be prevented by keeping the machine from running continuously without loads or with light loads for long period.

4.6.1 Procedure to Start the Unit

Follow the starting procedure below.

<Manual operations>

- ① Check and confirm that the circuit breaker "1" on the operation panel and the circuit breaker for auxiliary receptacle at output terminal portion are both "OFF".
- ② Set the selector switch "2" to "MANUAL" operation position.
- ③ Turning the starter switch "3" to the "RUN" position, the engine starts preheating automatically.
- ④ When the preheating lamp "4" goes off, turn the starter switch "3" to "START" position and start the engine.
- ⑤ Once engine has started, let it warm up about 5 minutes at no-load condition.
- ⑥ After finishing warming up operation, check and confirm frequency meter "5". If the frequency is wrong, turn frequency adjustment switch "6". If the frequency at load is adjusted higher than specified speed, turn selector switch to "DOWN" and if lower, turn to "UP" and adjust it to rated speed (rated frequency).
- ⑦ Adjust the voltage to the rated voltage by turning the voltage adjuster knob "8", watching the voltmeter "7".
- ⑧ Switch "ON" the circuit breaker and also the circuit breaker for auxiliary receptacle and then supply power to a load.

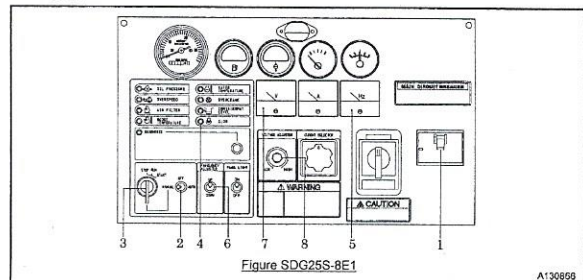

Figure SDG2SS-8E1

4-14

4. Operation

<Automatic operation>

WARNING Inspection and maintenance prohibited during automatic operation

- Never put your hands close to the interior of the machine, because the generator can be started when start signal functions even while the machine is in stop position.
- Before starting inspection and maintenance job, make sure to place the selector switch of automatic starting panel to "MAN" position and to hang the tag "Under inspection and maintenance".
- Remove the battery cathode cable terminal.
- Pull out the starter key of the generator and the inspector himself should keep it during inspection and maintenance job. neglect and/or ignoring the above items could cause a serious accident to other persons standing close by the machine when any other person than the inspector himself starts the machine.



1. Cable connection method of remote control switch

The remote control terminal "1" is provided inside the output terminal. Perform cable connection as shown below for remote control operation of the machine. For this cable connection job, make sure to remove the battery cathode cable terminal.

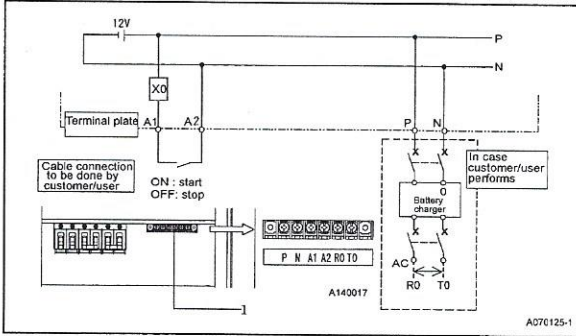

IMPORTANT Install the battery charger

- While the machine is in stand-by conditions during automatic operation, battery discharge occurs. Make sure to charge battery, operating the battery charger.

4-15

4. Operation

2. Operating procedure

- Start the generator unit under the procedure of manual operation and adjust the frequency and voltage.
- Turn the starter switch to "STOP" position and stop the engine.
- Turn the circuit breaker of output terminal "ON" after the generator unit stopped when you use the circuit breaker and single phase receptacle on the control panel.
- Turn the operating selector switch to "AUTO" position on the control panel, switch "ENGINE SPEED" switch to "HIGH" position.
- The unit will be under stand by and start once the start signal is sensed.

3. Function

When start signal activates in stand-by conditions, it starts the generator engine after preheating. When stop signal activates, it continues 70 seconds cooling down operation to stop engine and the machine is placed again in stand-by conditions.

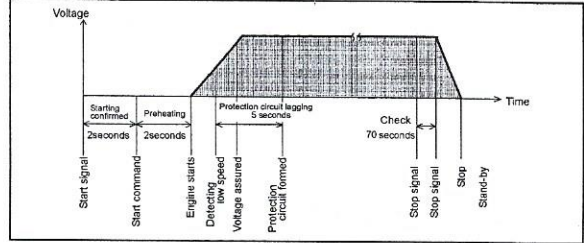

4. Starting action

Even when the engine will not start even after cranking operation for 10 seconds, stop it 8 seconds and then try cranking operation again. In case the engine will not start even after cranking operation is repeated three times, trouble signal goes on showing difficulty in starting.

In case that the lamp "OVERCRANK" goes on, switch off power supply once, pressing the button "EMERGENCY STOP". Then after releasing the button "EMERGENCY STOP", get rid of the cause of trouble why engine would not start.

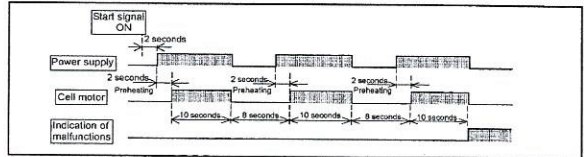

IMPORTANT Perform periodical inspection and maintenance of the generator

- For maintenance of the generator, try operation 5 to 10 minutes once a week.

4-16

4. Operation

4.6.2 Meter and Indicator Lights while Operating

During normal operation, each indication of instruments is shown in the table below. Refer to the table for daily checks.

Note: The values marked ※ vary with location of the voltage selector switch.

	Voltmeter (V)	Frequency meter (Hz)	Ammeter (A)	Monitor lamp										
				OIL PRESSURE	OVER SPEED	AIR FILTER	BOOST TEMP.	WATER TEMP.	OVER CRANK	CONTAINER LEVEL	GLOW	DIAGNOSIS		
Before Starting up (RUN)	0	0	0	●	●	●	●	●	●	●	●	●	●	●
During Operation	※ 240 480	60	Less than rated current	●	●	●	●	●	●	●	●	●	●	●

- Be sure to frequently check meters and indicators for proper operation, or any machine water, oil, fuel leaks, etc.
- The above table gives standard values. They may vary slightly depending on operating conditions and other factors.
- In single-phase load operation, check the current of L1, L2, and L3 phase with the ammeter, by turning the ammeter change-over switch. Each current should be balanced if unbalanced. Change load connections so the current of L1, L2, and L3 is equally balanced. Make sure that the current of each phase does not exceed the rated one.
- When the voltage selector switch is in the single-phase 240/120V position, place the ammeter change-over switch to the L1 or L3 position to read the output.

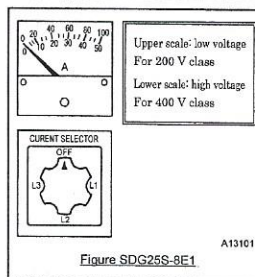

4.6.3 Panel light

- The instruments are provided with transmission type illuminators. Switch "ON" the panel light so that they may light on.
- When illumination is not necessary, turn "OFF" the light. (If the machine is always operated with the lamp switched "ON", the lamp life can be shortened.)

4-17

4. Operation

4.7 Stopping Procedures

<Procedure>

- Switch "OFF" the breaker on the operation panel of the generator.
- After performing cooling down operation about 5 minutes, place the starter switch to the "STOP" position to stop the engine.
- While the machine is kept unused, keep the operation selector switch placed to the "OFF" position.

4.8 Emergency Stop

CAUTION

- The Emergency Stop button should be used only for emergency stop.
- Regularly check the operating performance.

- If it is necessary to stop the generator for emergency, press the Emergency Stop button.

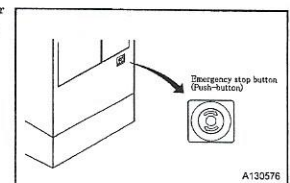

- To reset the button, turn the button head in the direction of the arrow. If it is not reset, the machine cannot restart to operate.

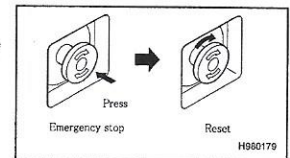

4-18

4. Operation

4.9 Air Bleeding

If the unit runs out of fuel, bleed the air, according to the following procedures.

<Procedure>

- ① Turn the "MANUAL·AUTO" selector switch to "MANUAL" position.
- ② Place starter switch to "OPERATION" position to keep electromagnet pump functioning.
- ③ Loosen "air bleeding plug" enough to move "Priming pump" (more often than 20 times) till fuel comes out.
- ④ Close "Air bleeding plug" and move "Priming pump" (more often than 10 times) till fuel is filled in fuel filter.
- ⑤ After waiting about 1 minute, loosen "Air bleeding plug" to bleed air from air filter.
- ⑥ Repeat the above procedures ②-④ till air does not come out from "Air bleeding plug" (at least more often than three times).
- ⑦ Perform warming up operation for 3 minutes after engine starts.
- ⑧ When this machine is not in use or operation, the "manual·auto" selector switch should be kept "OFF".

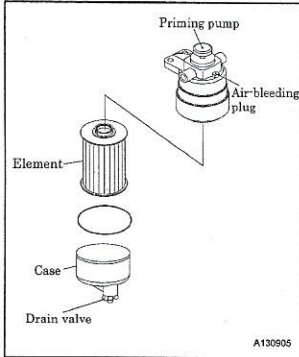

4-19

5. Failure cause and measures

5.1 Troubleshooting

- Should any trouble occur during operation, do not leave it. Investigate the cause and take appropriate measures.
- Read the manual carefully and fully understand what to do in case of trouble.
- The better you understand the construction and function of the unit, the faster you can find a problem and solution.
- This chapter describes the state, cause and countermeasures of important troubles in detail:
- When "DIAGNOSTIC LAMP" turn on, push "DIAGNOSTIC BUTTON" and check "FAULT CODE". See "OPERATOR'S MANUAL" and research the cause of trouble.

Symptom	Cause	Counter measures
Starter does not rotate. Low starter revolution speed even when starting.	(1) Battery malfunction	Check Battery→Charge/Change
Starter rotates but engine does not start up.	(1) Fuel filter clogging (2) Malfunction of controller (3) No diesel fuel oil (4) Air mixing in fuel pipings	Disassemble, clean, and change Check fuse Check connector Check controller Replenish fuel Bleed air
Engine oil pressure drop monitor lamp glows.	(1) Engine oil shortage (2) Engine oil filter clogging (3) Oil pressure switch malfunction (4) Loosened or disconnected wiring, or connector	Replenish fuel Change Change Check/repair
Coolant temperature rise monitor lamp glows.	(1) Radiator clogging (2) Faulty thermostat (3) Faulty coolant temperature switch (4) Shortage of coolant (5) Slip of belt (6) Looseness, disconnection of wiring or connectors	Clean Change Change Replenish Adjust tension Check/repair
The monitor lamp for air filter . . . clogging flickers.	(1) Air filter clogging	Clean
Oil fence monitor lamp glows.	(1) The condensate (fuel, engine oil and coolant) is accumulated in the oil fence. (2) The liquid surface level detecting switch does not function good.	Drain the condensate. Check/change

5-1

5. Failure cause and measures

Symptom	Cause	Counter measures
Circuit breaker trips.	(1) Overloaded (2) Short-circuit occurred at the load side.	Reduce the load Get rid of cause of short-circuiting.
Even when operated at a rated speed, no voltage or too low voltage generated.	(1) Faulty voltmeter (2) Poor tightening of terminals (3) Broken or short-circuited winding of generator main unit (4) Faulty AVR (5) Faulty silicon rectifier (mounted on generator rotor) (6) Faulty exciter (7) Broken or short-circuited circuit to exciter field winding (8) Function circuit protector (CP) for AVR protection	Check/change Check/repair Check/repair Check/change Check/change Check/repair Check/repair Reset
Too high voltage generated when set at the rated frequency (50Hz/60Hz). Voltage will not drop even when the voltage regulator controlling knob is turned.	(1) Loosened or disconnected wiring, or connector to AVR (2) Faulty AVR (3) Broken wire or poor contact of AVR variable resistor	Check/repair Check/change Repair or change
Unstable voltage generation	(1) Poor tightening of each terminal (2) Faulty AVR (3) Function circuit protector (CP) for AVR protection	Check/repair Check/change Reset

- Please contact your nearest dealer if you find it difficult to repair by yourselves.
- Please refer to the engine operation manual for troubles concerning the engine.

5-2

5. Failure cause and measures

5.1.1 Engine trouble

- This is equipped with controller which memorizes engine troubles. When engine fails, trouble diagnosis lamp "1" lights. For the details of the troubles, press trouble diagnosis switch "2" and then the trouble conditions are displayed.
- <Procedure>
- ① Turn starter switch to "Operation" position and continue pressing trouble diagnosis switch "2".
 - ② If there are any troubles while pressing the switch, blinking pattern of trouble diagnosis lamp "1" shows details of the troubles.
- Special knowledge on trouble conditions is required. So please contact your distributor or directly us.

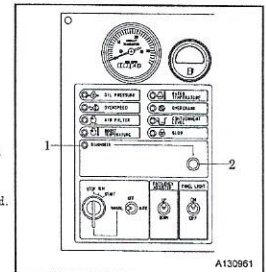

[Example of diagnosis lamp lighting]

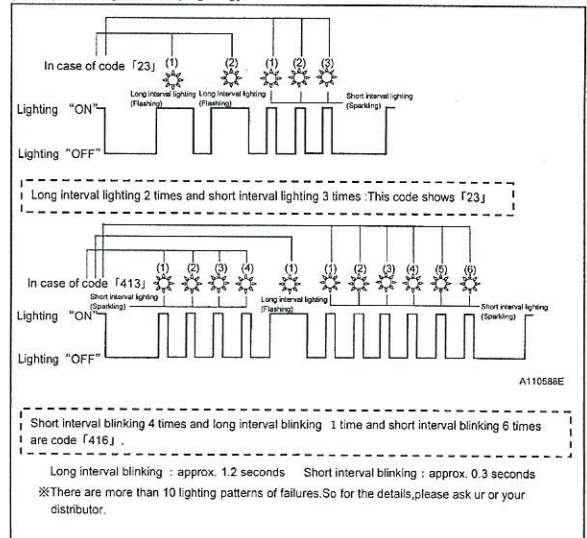

5-3